

# LTR-P Professional Series

## 3W, 12VDC and 24VDC LED Tape Specification Sheet



|              |      |
|--------------|------|
| Project Name | Type |
|--------------|------|

|           |      |
|-----------|------|
| Catalog # | Date |
|-----------|------|

### PRODUCT OVERVIEW

GM's Professional Series Flexible LED Tape combines style and technology with reliability. Designed for professional installations that demand a high level of quality, the LTR-P Series includes a wide array of key features and is available in 16'-4" (5M) and 100' (30M) reels.

### FEATURES

- 12VDC or 24VDC models
- 2400K, 2700K, 3000K, 3500K, 4000K and 5000K color temps
- Remote control with GM's LUXcontrol™ App and controllers
- Maximum run on a given lead is 16'-4"(12V) and 32'-8"(24V)
- Dry location
- 120 LEDs per meter
- Cuttable every 2"
- Custom lengths available - consult factory
- Includes Sure-Tite connectors
- Premium diodes
- 120° viewing angle
- Dimmable
- 3M adhesive back

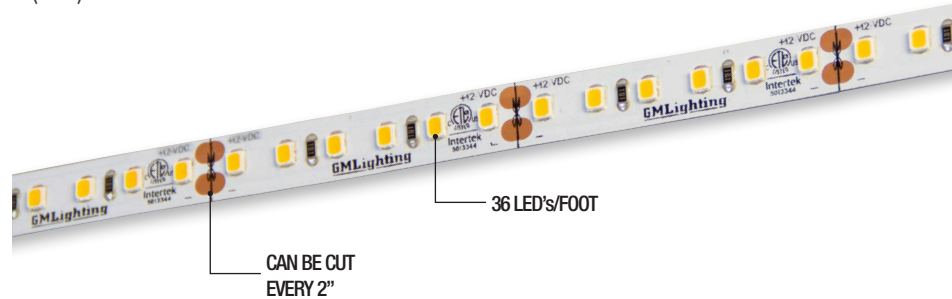

### SPECIFICATIONS

#### ELECTRICAL

- 12V/24V
- 3 watts per foot

#### OPTICS

- 90+ CRI

#### OPERATING TEMP

- -4F to 122 F

#### CERTIFICATION

- ETL (12V) / UL (24V)
- Title 24 compliant when used with used with specific drivers. Consult factory.
- Class 2
- Closet Rated: Complies with NEC code (NFPA70) 410.16, Suitable for installation within the clothes closet storage space

#### WARRANTY

- 5-year warranty when paired with GM power supply

Note: Do not install in an application that is not easily accessed for service. Our warranty covers product only and does not cover any labor or incidental charges related to service or warranty.

### ORDERING INFORMATION

Example: LTR-P-12V-3W-24K-16

| Model | Series | Voltage | Wattage | Color Temp | Reel Length |
|-------|--------|---------|---------|------------|-------------|
| LTR   | P      | 12V     | 3W      | 24K        | 16          |
|       |        |         |         | 27K        |             |
|       |        | 24V     |         | 30K        | 100         |
|       |        | 35K     |         |            |             |
|       |        | 40K     |         |            |             |
| 50K   |        |         |         |            |             |

\*Reel Length: 16 = 16'-4", 100 = 98'-6"

### ACCESSORIES

| Model    | Description  |
|----------|--|
| ESTC-1   | Sure-Tite tape to tape connector                   |
| ESTC-90  | Sure-Tite 90° connector                            |
| ESTLK-60 | Sure-Tite 60" adjustable tape to tape connector    |
| ESTW-60  | Sure-Tite 60" adjustable tape to power connector   |
| ESTW-CO  | Sure-Tite tape to power supply connector (no wire) |

#### Your LED Tape Specification Checklist:

1. Select Tape
2. Select Connectors
3. Select Channels
4. Select Controllers or Dimmers
5. Select Power Supplies

Install Sheet



# LTR-P Professional Series

## 3W, 12VDC and 24VDC LED Tape Specification Sheet



| Catalog No.          | Length       | Lumens | CRI | Color Temp. | Max. Run |
|----------------------|--------------|--------|-----|-------------|----------|
| LTR-P-12V-3W-24K-16  | 16'-4" / 5M  | 211    | 90+ | 2400K       | 16'-4"   |
| LTR-P-12V-3W-27K-16  | 16'-4" / 5M  | 225    | 90+ | 2700K       | 16'-4"   |
| LTR-P-12V-3W-30K-16  | 16'-4" / 5M  | 242    | 90+ | 3000K       | 16'-4"   |
| LTR-P-12V-3W-35K-16  | 16'-4" / 5M  | 246    | 90+ | 3500K       | 16'-4"   |
| LTR-P-12V-3W-40K-16  | 16'-4" / 5M  | 251    | 90+ | 4000K       | 16'-4"   |
| LTR-P-12V-3W-50K-16  | 16'-4" / 5M  | 254    | 90+ | 5000K       | 16'-4"   |
| LTR-P-12V-3W-24K-100 | 98'-6" / 30M | 211    | 90+ | 2400K       | 16'-4"   |
| LTR-P-12V-3W-27K-100 | 98'-6" / 30M | 225    | 90+ | 2700K       | 16'-4"   |
| LTR-P-12V-3W-30K-100 | 98'-6" / 30M | 242    | 90+ | 3000K       | 16'-4"   |
| LTR-P-12V-3W-35K-100 | 98'-6" / 30M | 246    | 90+ | 3500K       | 16'-4"   |
| LTR-P-12V-3W-40K-100 | 98'-6" / 30M | 251    | 90+ | 4000K       | 16'-4"   |
| LTR-P-12V-3W-50K-100 | 98'-6" / 30M | 254    | 90+ | 5000K       | 16'-4"   |
| LTR-P-24V-3W-24K-16  | 16'-4" / 5M  | 211    | 90+ | 2400K       | 32'-8"   |
| LTR-P-24V-3W-27K-16  | 16'-4" / 5M  | 225    | 90+ | 2700K       | 32'-8"   |
| LTR-P-24V-3W-30K-16  | 16'-4" / 5M  | 242    | 90+ | 3000K       | 32'-8"   |
| LTR-P-24V-3W-35K-16  | 16'-4" / 5M  | 246    | 90+ | 3500K       | 32'-8"   |
| LTR-P-24V-3W-40K-16  | 16'-4" / 5M  | 251    | 90+ | 4000K       | 32'-8"   |
| LTR-P-24V-3W-50K-16  | 16'-4" / 5M  | 254    | 90+ | 5000K       | 32'-8"   |
| LTR-P-24V-3W-24K-100 | 98'-6" / 30M | 211    | 90+ | 2400K       | 32'-8"   |
| LTR-P-24V-3W-27K-100 | 98'-6" / 30M | 225    | 90+ | 2700K       | 32'-8"   |
| LTR-P-24V-3W-30K-100 | 98'-6" / 30M | 242    | 90+ | 3000K       | 32'-8"   |
| LTR-P-24V-3W-35K-100 | 98'-6" / 30M | 246    | 90+ | 3500K       | 32'-8"   |
| LTR-P-24V-3W-40K-100 | 98'-6" / 30M | 251    | 90+ | 4000K       | 32'-8"   |
| LTR-P-24V-3W-50K-100 | 98'-6" / 30M | 254    | 90+ | 5000K       | 32'-8"   |

Kelvin temperature (color) ±100K.  
 16'-4" and 100' reel includes 48" lead affixed to tape. 16'-4" reel includes (3) ESTW-60 Sure-Tite connectors.  
 100' reel includes (10) ESTW-60 Sure-Tite connectors

### COMPATIBLE CONTROLLERS

| Model              | Description  |
|--------------------|--|
| SHWC               | LUXcontrol Smart 2.4 GHz WiFi Controller, Standard 12V/24V Low Voltage |
| SHWD               | LUXcontrol Smart 2.4 GHz WiFi Dimmer, Standard 12V/24V Low Voltage     |
| SWD-40W-12VDC-DIM  | SwitchLD All-in-One Dimmer and Driver, 40W, 12VDC                      |
| SWD-60W-12VDC-DIM  | SwitchLD All-in-One Dimmer and Driver, 60W, 12VDC                      |
| SWD-60W-24VDC-DIM  | SwitchLD All-in-One Dimmer and Driver, 60W, 24VDC                      |
| SWD-100W-24VDC-DIM | SwitchLD All-in-One Dimmer and Driver, 100W, 24VDC                     |
| HC-RF-UNV-5CH      | Universal 1-5 Channel RF Remote Control                                |
| CM-RF-UNV-5CH      | Universal 1-5 Channel Control Module                                   |
| RPT-UNV-5CH        | Universal 1-5 Channel Repeater Amplifier                               |

# LTR-P Professional Series

## 3W, 12VDC and 24VDC LED Tape Specification Sheet



### RECOMMENDED DRIVERS

| Catalog No. | Description  | Watts                                | Specification Sheet |
|-------------|--|--------------------------------------|---------------------|
| LD-XD-UNV   | LineDrive Electronic Multi-Dimmable Power Supply, 12VDC or 24VDC | 20W, 40W, 60W, 96W, 180W, 200W, 300W | View Spec Sheet     |
| LD-E-UNV    | LineDrive Electronic Non-Dimmable Power Supply, 12VDC or 24VDC   | 30W, 60W, 96W, 200W, 300W            | View Spec Sheet     |
| LD-MD-UNV   | LineDrive Magnetic Dimmable Power Supply, 12VDC or 24VDC         | 30W, 60W, 96W, 150W, 200W, 300W      | View Spec Sheet     |
| LD-EDM      | LineDrive Electronic Dimmable MINI Power Supply, 12VDC or 24VDC  | 60W                                  | View Spec Sheet     |
| LTP         | Cord and Plug Power Supply, 12VDC or 24VDC                       | 25W, 48W, 60W, 90W                   | View Spec Sheet     |
| PSD         | Electronic Dimmable Power Supply, 12VDC or 24VDC                 | 15W, 24W, 60W, 90W                   | View Spec Sheet     |

Please see our website for updated power supply specifications and information.

### DIMENSION

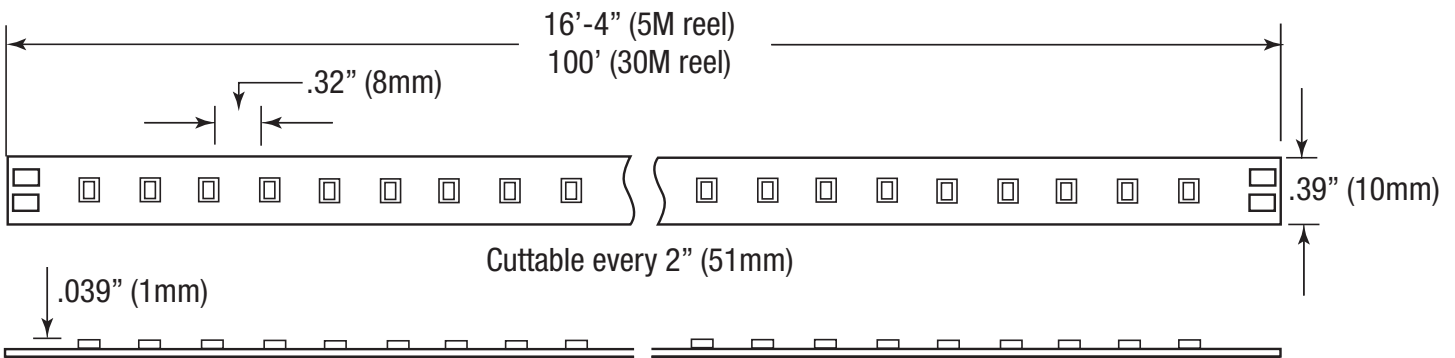

### EST SERIES CONNECTORS

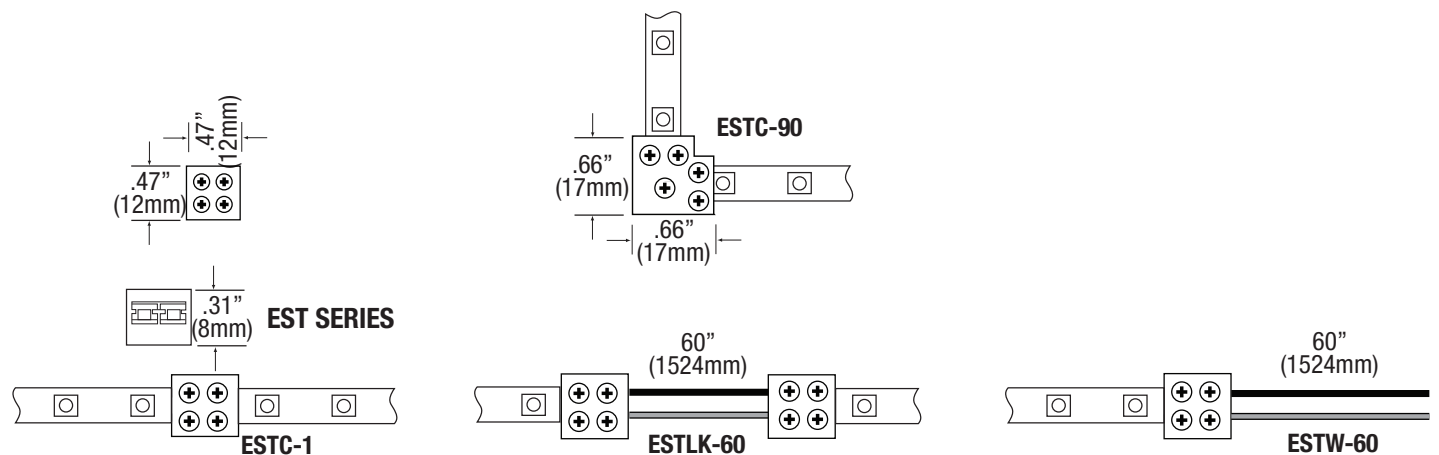

# LTR-P Professional Series

## 3W, 12VDC and 24VDC LED Tape Specification Sheet



### COMPATIBLE CHANNELS - FIT CONNECTORS ON PG. 1

#### EXTRA DEEP

| Catalog No.    | Description   | Length | Dimensions |
|----------------|---|--------|------------|
| LED-CHL-XD     | Extra deep format extruded channel. Includes snap-on frosted lens with mounting clips and screws. | 4'     |            |
| LED-CHL-XD-6   | Extra deep format extruded channel. Includes snap-on frosted lens with mounting clips and screws. | 6'     |            |
| LED-CHL-XD-AMC | (2) Adjustable mounting brackets for LED-CHL-XD   | N/A    |            |
| LED-CHL-XD-EC  | (2) End caps for LED-CHL-XD. One solid, one with hole.  | N/A    |            |
| LED-CHL-XD-MC  | (2) Mounting clips and screws for LED-CHL-XD  | N/A    |            |

#### EXTRA DEEP FLANGED

|                 |   |     |  |
|-----------------|---|-----|--|
| LED-CHL-XD-F    | Extra deep format extruded channel with flange. Includes snap-on frosted lens with mounting clips and screws. | 4'  |  |
| LED-CHL-XD-F-6  | Extra deep format extruded channel with flange. Includes snap-on frosted lens with mounting clips and screws. | 6'  |  |
| LED-CHL-XD-F-DC | (2) Drywall mounting brackets for LED-CHL-XD-F  | N/A |  |
| LED-CHL-XD-F-EC | (2) End caps for LED-CHL-XD-F. One solid, one with hole.  | N/A |  |

#### MINI DEEP

|                    |  |     |  |
|--------------------|--|-----|--|
| LED-CHL-XD-MD      | Mini deep format extruded channel. Includes snap-on frosted lens with mounting clips and screws.             | 4'  |  |
| LED-CHL-XD-MD-WH   | Mini deep format extruded channel. Includes snap-on frosted lens with mounting clips and screws. White.      | 4'  |  |
| LED-CHL-XD-MD-B    | Mini deep format extruded channel. Includes snap-on frosted lens with mounting clips and screws. Black.      | 4'  |  |
| LED-CHL-XD-MD-6    | Mini deep format extruded channel with flange. Includes snap-on frosted lens with mounting clips and screws. | 6'  |  |
| LED-CHL-XD-MD-6-WH | Mini deep format extruded channel. Includes snap-on frosted lens with mounting clips and screws. White.      | 6'  |  |
| LED-CHL-XD-MD-6-B  | Mini deep format extruded channel. Includes snap-on frosted lens with mounting clips and screws. Black.      | 6'  |  |
| LED-CHL-XD-MD-AMC  | (2) Adjustable mounting brackets for LED-CHL-XD-MD   | N/A |  |
| LED-CHL-XD-MD-EC   | (2) End caps for LED-CHL-XD-MD. One solid, one with hole.  | N/A |  |
| LED-CHL-XD-MD-MC   | (2) Mounting clips for LED-CHL-XD-MD   | N/A |  |

#### MINI DEEP FLANGED

|                      |   |     |  |
|----------------------|---|-----|--|
| LED-CHL-XD-MD-F      | Mini deep format flanged extruded channel with flange. Includes snap-on frosted lens with mounting clips and screws.        | 4'  |  |
| LED-CHL-XD-MD-F-WH   | Mini deep format flanged extruded channel with flange. Includes snap-on frosted lens with mounting clips and screws. White. | 4'  |  |
| LED-CHL-XD-MD-F-B    | Mini deep format flanged extruded channel with flange. Includes snap-on frosted lens with mounting clips and screws. Black. | 4'  |  |
| LED-CHL-XD-MD-F-6    | Mini deep format extruded flanged channel with flange. Includes snap-on frosted lens with mounting clips and screws.        | 6'  |  |
| LED-CHL-XD-MD-F-6-WH | Mini deep format extruded flanged channel with flange. Includes snap-on frosted lens with mounting clips and screws. White. | 6'  |  |
| LED-CHL-XD-MD-F-6-B  | Mini deep format extruded flanged channel with flange. Includes snap-on frosted lens with mounting clips and screws. Black. | 6'  |  |
| LED-CHL-XD-MD-F-DC   | (2) Drywall mounting brackets for LED-CHL-XD-MD-F   | N/A |  |
| LED-CHL-XD-MD-F-EC   | (2) End caps for LED-CHL-XD-MD-F. One solid, one with hole.   | N/A |  |

# LTR-P Professional Series

## 3W, 12VDC and 24VDC LED Tape Specification Sheet



### COMPATIBLE CHANNELS- FIT CONNECTORS ON PG. 1

#### 45° ANGLE MOUNT

| Catalog No.   | Description  |     | Dimensions |
|---------------|--|-----|------------|
| LED-CHL-45    | Extruded angled (45°) channel. Includes snap-on frosted lens with mounting clips and screws. | 4'  |            |
| LED-CHL-45-EC | (2) End caps for LED-CHL-45 - one solid, one with hole                                       | N/A |            |
| LED-CHL-45-MC | (2) Mounting clips and screws for LED-CHL-45   | N/A |            |

#### 45° LARGE ANGLE MOUNT

|                    |  |     |  |
|--------------------|--|-----|--|
| LED-CHL-45-1200    | Extruded angled (45°) channel. Includes snap-on frosted lens with mounting clips and screws. | 4'  |  |
| LED-CHL-45-1200-EC | (2) End caps for LED-CHL-45 - one solid, one with hole                                       | N/A |  |
| LED-CHL-45-1200-MC | (2) Additional mounting clips for LED-CHL-45-1200  | N/A |  |

#### WIDE

|               |   |     |  |
|---------------|---|-----|--|
| LED-CHL-W     | Wide format extruded channel. Includes snap-on frosted lens with mounting clips and screws. | 4'  |  |
| LED-CHL-W-6   | Wide format extruded channel. Includes snap-on frosted lens with mounting clips and screws. | 6'  |  |
| LED-CHL-W-AMC | (2) Adjustable mounting brackets for LED-CHL-W  | N/A |  |
| LED-CHL-W-EC  | (2) End caps for LED-CHL-W - one solid, one with hole.                                      | N/A |  |
| LED-CHL-W-MC  | (2) Additional mounting clips for LED-CHL-W   | N/A |  |

#### MUD IN - STANDARD

|                  |   |     |  |
|------------------|---|-----|--|
| LED-CHL-MI-ST6   | Standard extruded aluminum mud-in channel. Includes snap-on frosted lens. | 6'  |  |
| LED-CHL-MI-ST-EC | (2) End caps for LED-CHL-MI-ST6 one solid, one with hole.                 | N/A |  |

#### STANDARD STRAIGHT

|                    |  |     |  |
|--------------------|--|-----|--|
| LED-CHL2-4-CA      | Silver channel, white lens (2) mounting clips, (2) screws          | 4'  |  |
| LED-CHL2-4-WH      | White channel, white lens (2) mounting clips, (2) screws           | 4'  |  |
| LED-CHL2-4-BK      | Black channel, white lens (2) mounting clips, (2) screws           | 4'  |  |
| LED-CHL2-6-CA      | Silver channel, white lens, (4) mounting clips, (4) screws         | 6'  |  |
| LED-CHL2-6-WH      | White channel, white lens, (4) mounting clips, (4) screws          | 6'  |  |
| LED-CHL2-6-BK      | Black channel, white lens, (4) mounting clips, (4) screws          | 6'  |  |
| LED-CHL2 LENS-4-BK | Lens in black for LED-CHL2-4                                       | 4'  |  |
| LED-CHL2 LENS-6-BK | Lens in black for LED-CHL2-6                                       | 6'  |  |
| LED-CHL2-ECG       | (2) End caps for LED-CHL2-CA: light gray, one solid, one with hole | N/A |  |
| LED-CHL2-ECW       | (2) End caps for LED-CHL2-WH: white, one solid, one with hole      | N/A |  |
| LED-CHL2-ECB       | (2) End caps for LED-CHL2-BK: black, one solid, one with hole      | N/A |  |
| LED-CHL2-MC        | (2) Mounting clips and (2) screws                                  | N/A |  |
| LED-CHL2-AMC       | (2) Adjustable mounting clips and (2) screws                       | N/A |  |

# LTR-P Professional Series

## 3W, 12VDC and 24VDC LED Tape Specification Sheet



### COMPATIBLE CHANNELS - SOLDERED LEADS ONLY

#### STANDARD STRAIGHT

| Catalog No. | Description   |     | Dimensions |
|-------------|---|-----|------------|
| LED-CHL     | Extruded channel. Includes snap-on frosted lens with mounting clips and screws. | 4'  |            |
| LED-CHL-6   | Extruded channel. Includes snap-on frosted lens with mounting clips and screws. | 6'  |            |
| LED-CHL-AMC | (2) Adjustable mounting brackets for LED-CHL                                    | N/A |            |
| LED-CHL-EC  | (2) End caps for LED-CHL - one solid, one with hole.                            | N/A |            |
| LED-CHL-MC  | (2) Additional mounting clips for LED-CHL                                       | N/A |            |

#### 45° MINI ANGLE MOUNT

|                      |   |     |  |
|----------------------|---|-----|--|
| LED-CHL-45-MINI      | Extruded angled (45°) silver channel. Includes snap-on white lens with (2) mounting clips and (2) screws. | 4'  |  |
| LED-CHL-45-MINI-B    | Extruded angled (45°) black channel. Includes snap-on white lens with (2) mounting clips and (2) screws.  | 4'  |  |
| LED-CHL-45-MINI-EC   | (2) End caps for LED-CHL-45-MINI: light gray, one solid, one with hole                                    | N/A |  |
| LED-CHL-45-MINI-EC-B | (2) End caps for LED-CHL-MINI-B: black, one solid, one with hole  | N/A |  |
| LED-CHL-45-MINI-MC   | (2) Mounting clips and (2) screws for LED-CHL-45-MINI   | N/A |  |
| LED-CHL-45-M-LENS-BK | Lens in black for LED-CHL-45-MINI   | 4'  |  |

# LTR-P Professional Series

## 3W, 12VDC and 24VDC LED Tape Specification Sheet



### SHWC LUXCONTROL WIFI CONTROLLER

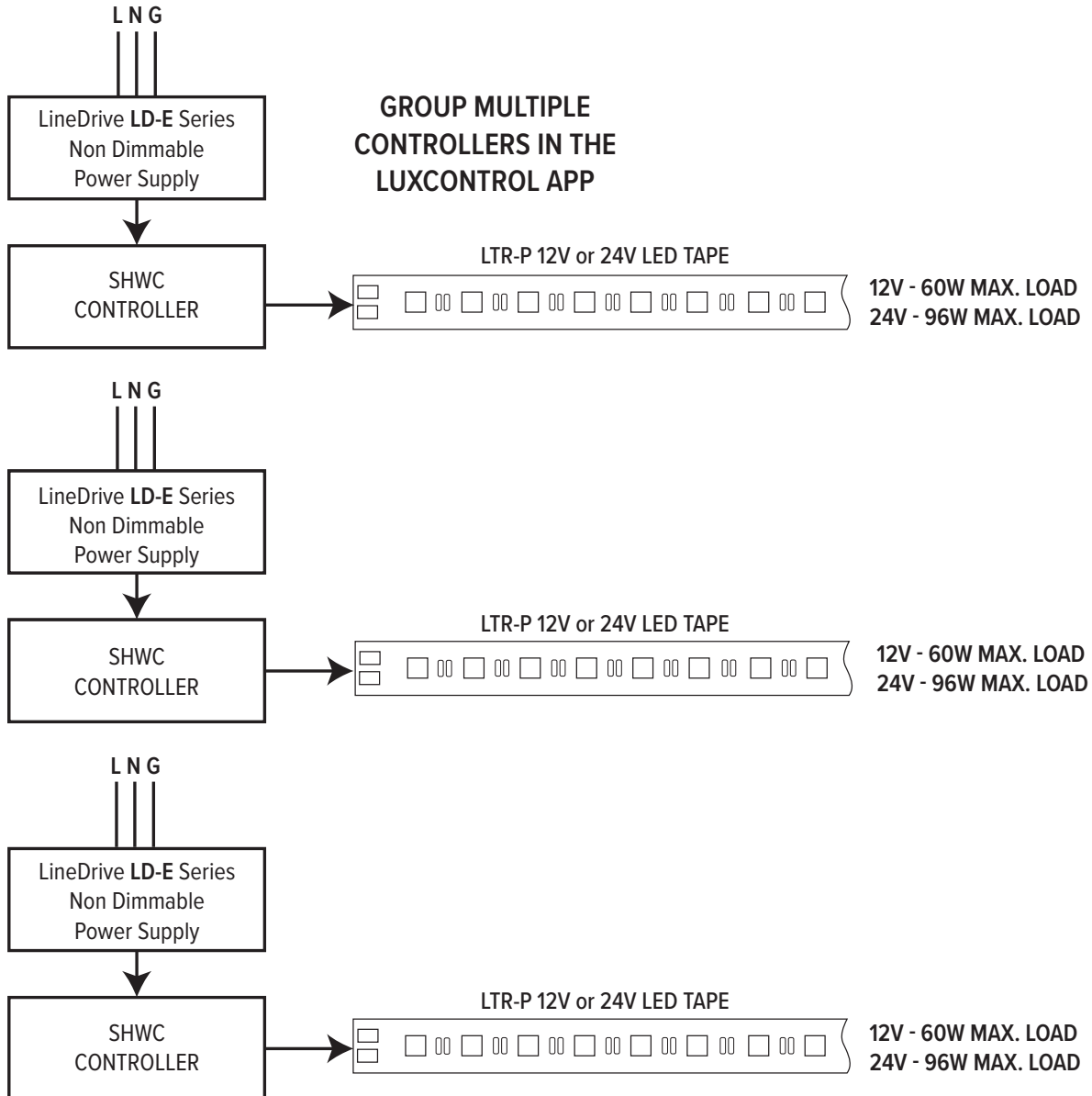

# LTR-P Professional Series

## 3W, 12VDC and 24VDC LED Tape Specification Sheet



### SHWC LUXCONTROL WIFI CONTROLLER WITH POWER REPEATER

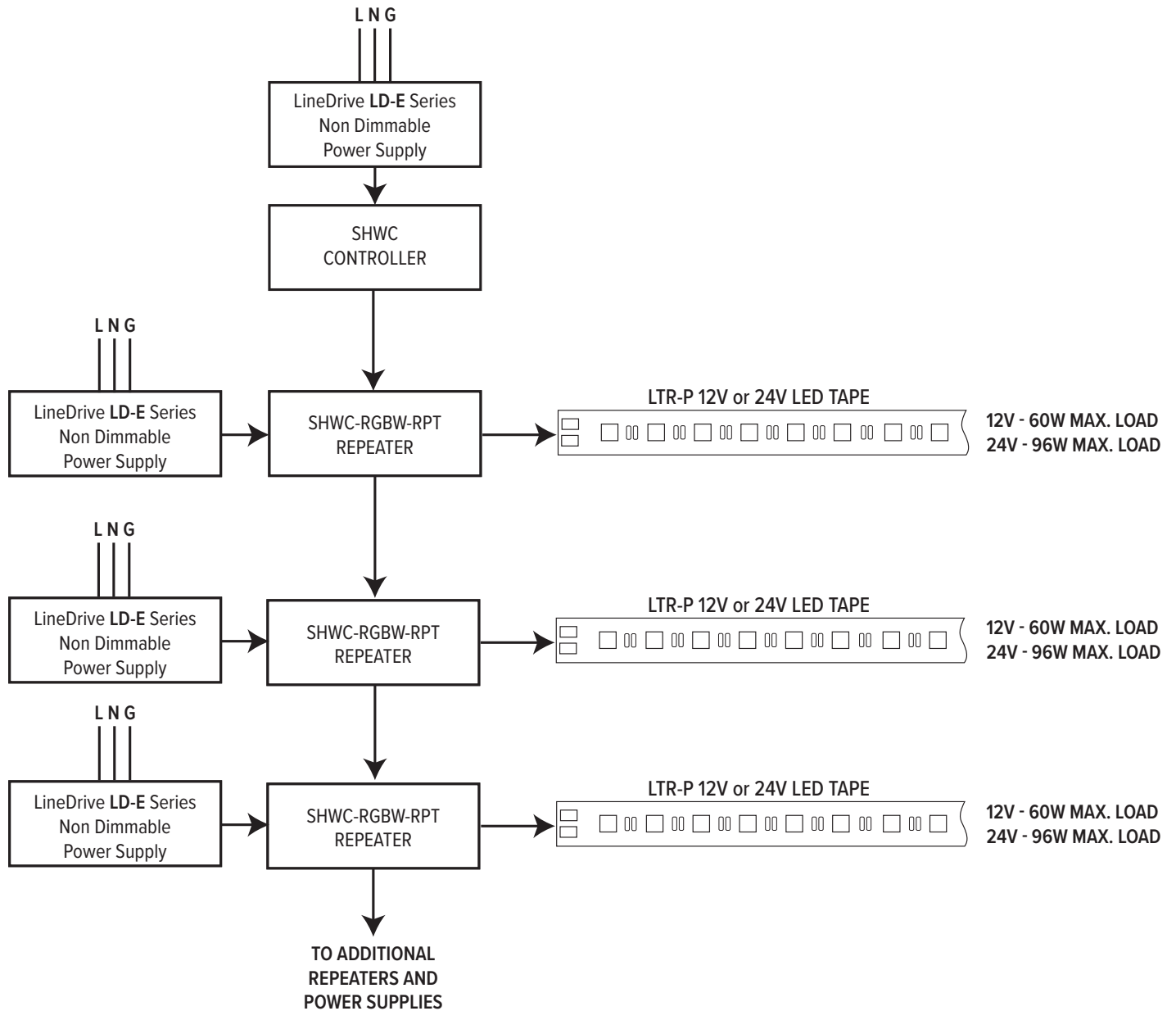



# LTR-P Professional Series

## 3W, 12VDC and 24VDC LED Tape Specification Sheet



### SHWD LUXCONTROL WIFI DIMMER

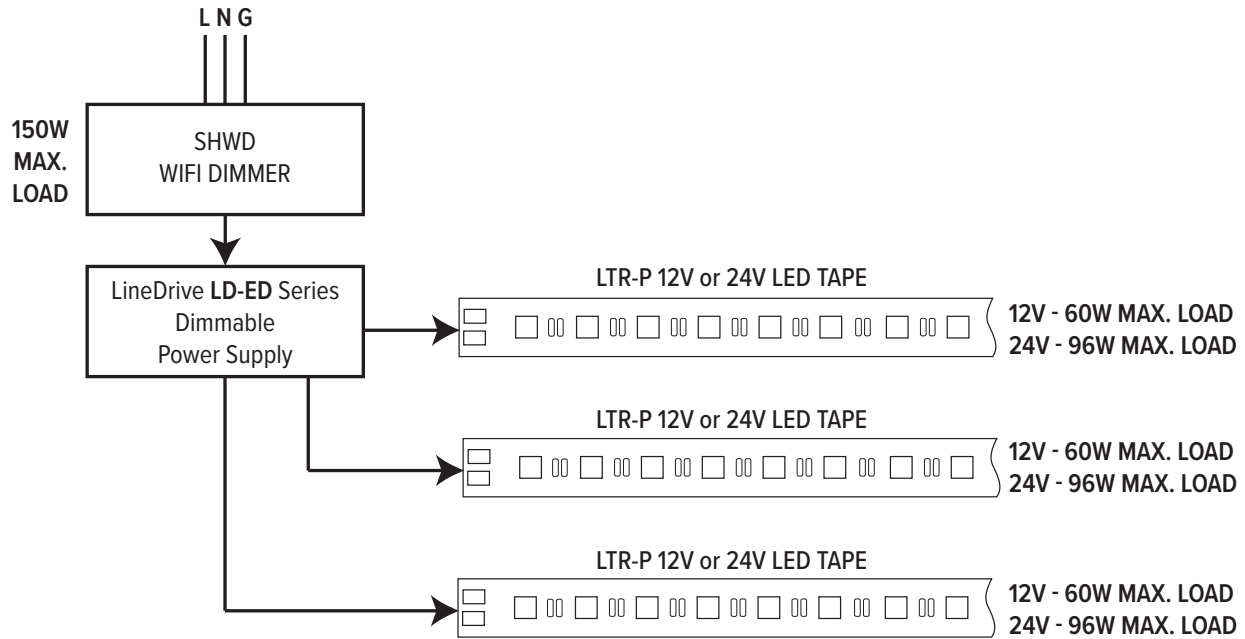

### SWITCHLD SWD DRIVER AND DIMMER

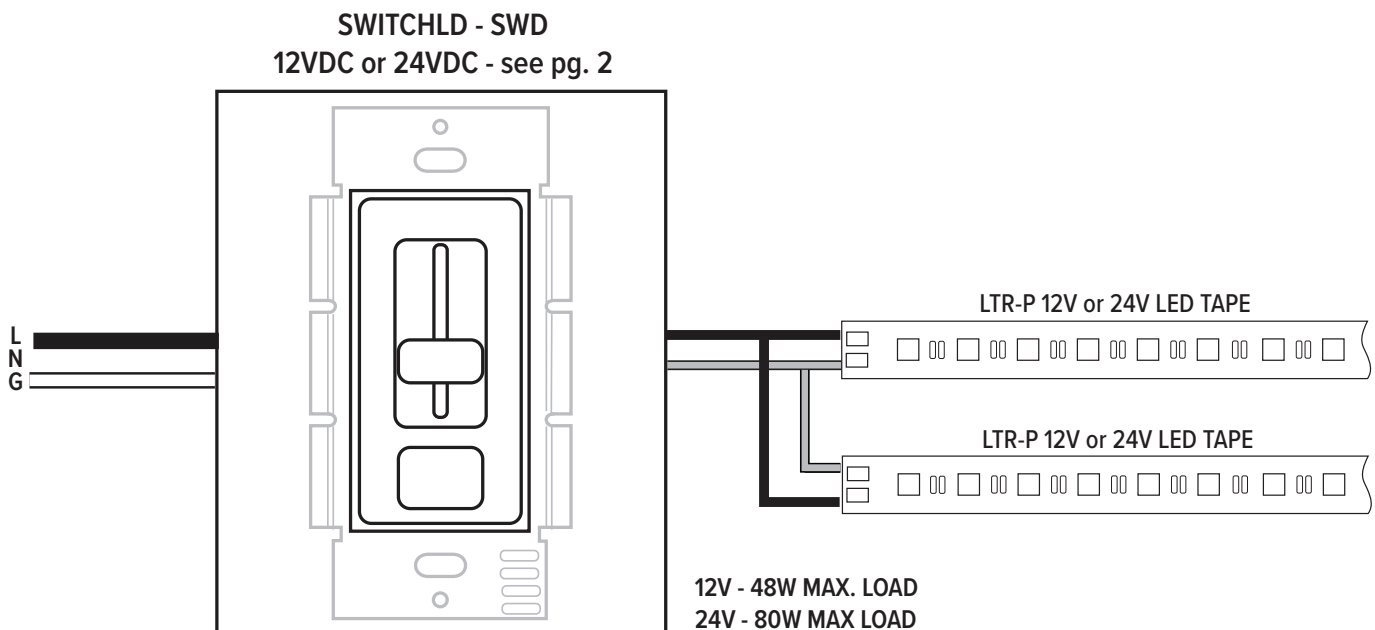

# LTR-P Professional Series

## 3W, 12VDC and 24VDC LED Tape Specification Sheet



### RF CONTROLLER

Incoming power for (L N G) options can be 120V or 277V.  
 Check power supply for proper input voltage and output power required.  
 Power Supply output voltage must match LED operating voltage. (24VDC)  
 Power supply used **MUST NOT BE DIMMED** at the input to properly power the controls.  
 See Controller instructions for pairing and wiring details.

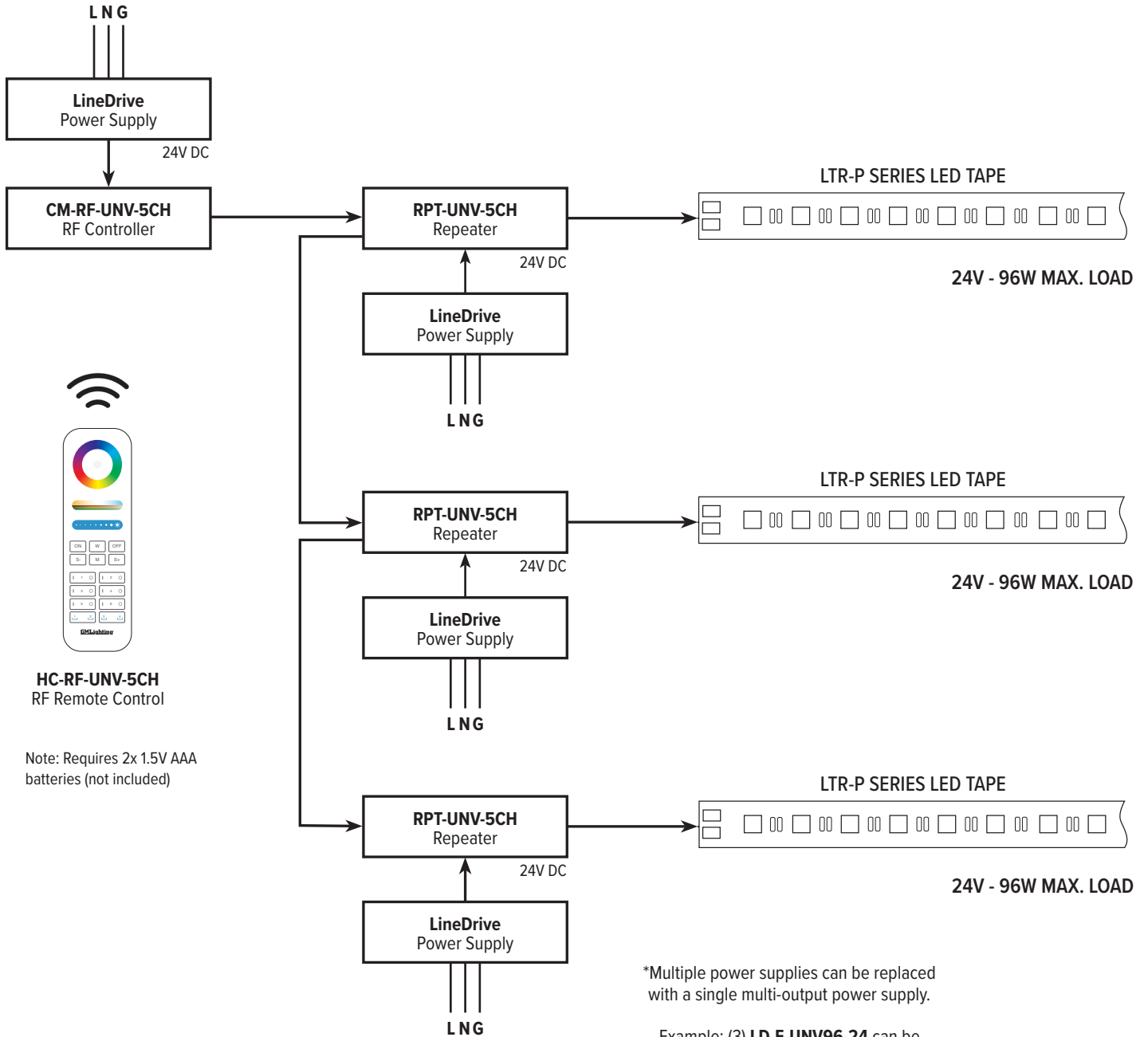

\*Multiple power supplies can be replaced with a single multi-output power supply.

Example: (3) **LD-E-UNV96-24** can be replaced by (1) **LD-E-UNV300-24**

# LTR-P Professional Series

## 3W, 12VDC and 24VDC LED Tape Specification Sheet



### RF REMOTE CONTROLLER AND REPEATER

Use 12V or 24V dc to match LED voltage

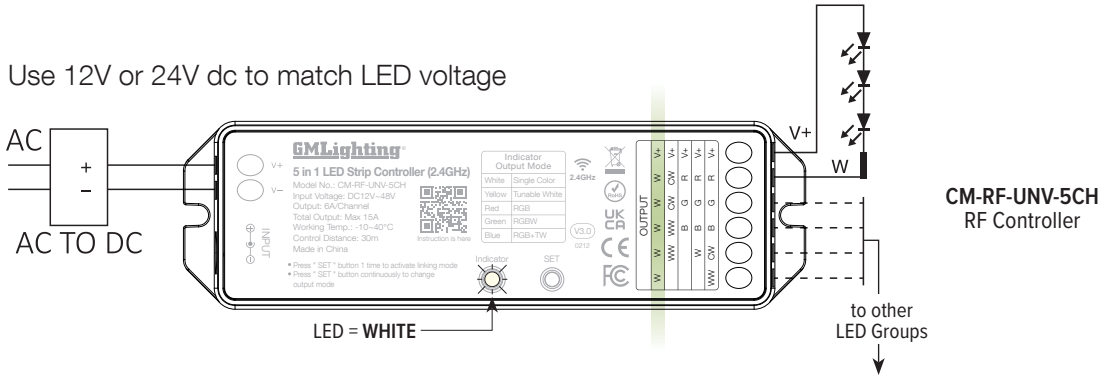

### DIMENSIONS

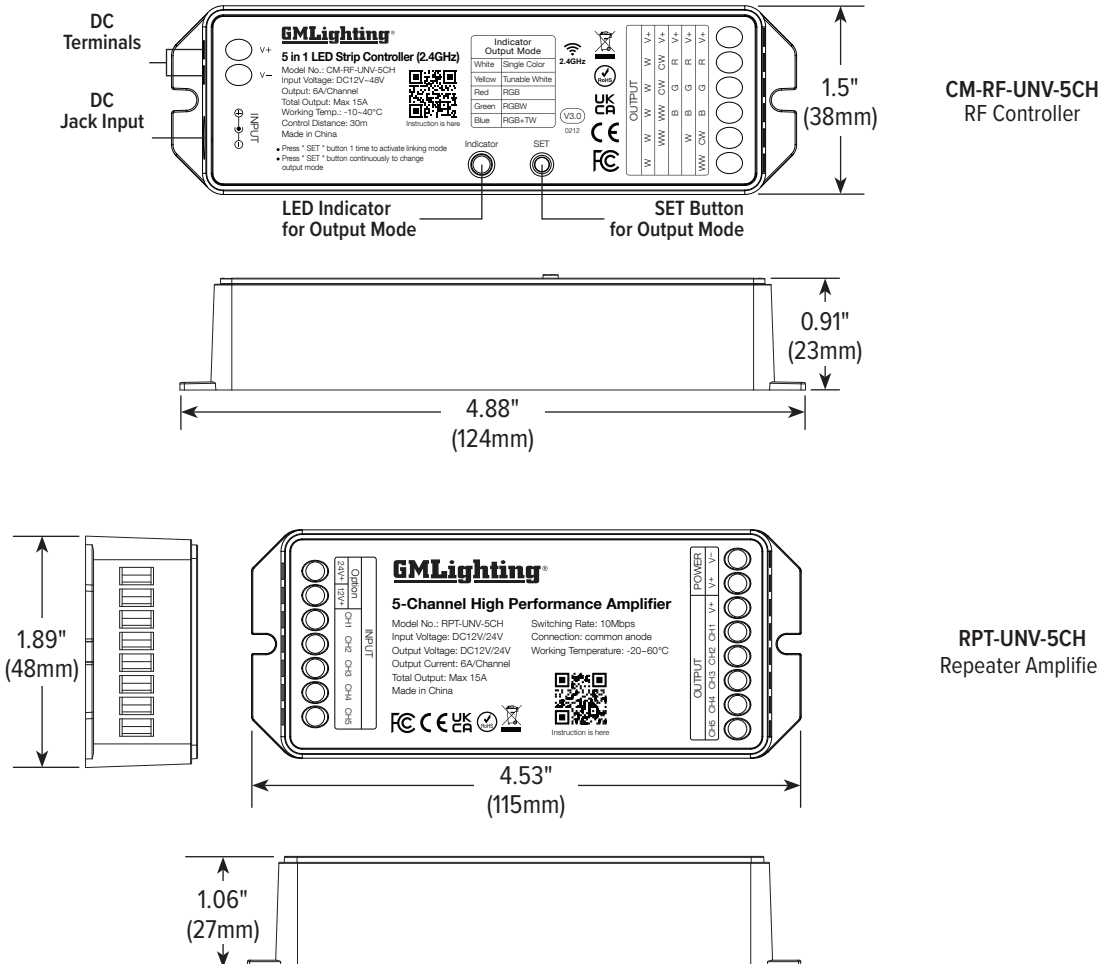

# LTR-P Professional Series

3W, 12VDC and 24VDC  
LED Tape Specification Sheet



## RF HAND HELD REMOTE FEATURES AND DIMENSIONS

RF Remote Control  
**HC-RF-UNV-5CH**  
with Built-In Effects

